

6" submersible pump



Clean water
(Maximum
sand content 100 g/m³)



Civil use



Agricultural use



PERFORMANCE RANGE

- Flow rate up to **1000 l/min** (60 m³/h)
- Head up to **390 m**

APPLICATION LIMITS

- Maximum liquid temperature **+35 °C**
- Maximum sand content **100 g/m³**
- **200 m** immersion limit
- Installation:
 - vertical
 - horizontal, with the following limits: up to **12 stages** or **11 kW**
- Starts/hour: **20** at regular intervals
- Minimum flow rate for motor cooling **16 cm/s** (50 cm/s for 30 kW)
- Continuous service **S1**

CONSTRUCTION AND SAFETY STANDARDS

ELECTRIC MOTOR

– Three-phase 400 V - 50 Hz

4 m long power cable

EN 60335-1
IEC 60335-1
CEI 61-150

EN 60034-1
IEC 60034-1
CEI 2-3



EU REGULATION N. 547/2012

CERTIFICATIONS

Company with management system certified DNV
ISO 9001: QUALITY



INSTALLATION AND USE

Suitable for use with clean water with a sand content of no more than **100 g/m³**. Because of their high efficiency and reliability, they are suitable for use in civil, agricultural and industrial applications such as the distribution of water in combination with pressure tanks, for irrigation and for pressure boosting in fire-fighting sets, etc.

OPTIONS AVAILABLE ON REQUEST

- Kit of cooling jacket complete with filter and supports
- 6SR-HYD pumps with double cable cover suitable for dual voltage 400/690 V (star/delta) motors from 11 kW to 30 kW
- Other voltages or 60 Hz frequency
- **Kit of cooling jacket complete with filter and supports**



COOLING JACKET

CHARACTERISTIC CURVES AND PERFORMANCE DATA

50 Hz n = 2900 min⁻¹

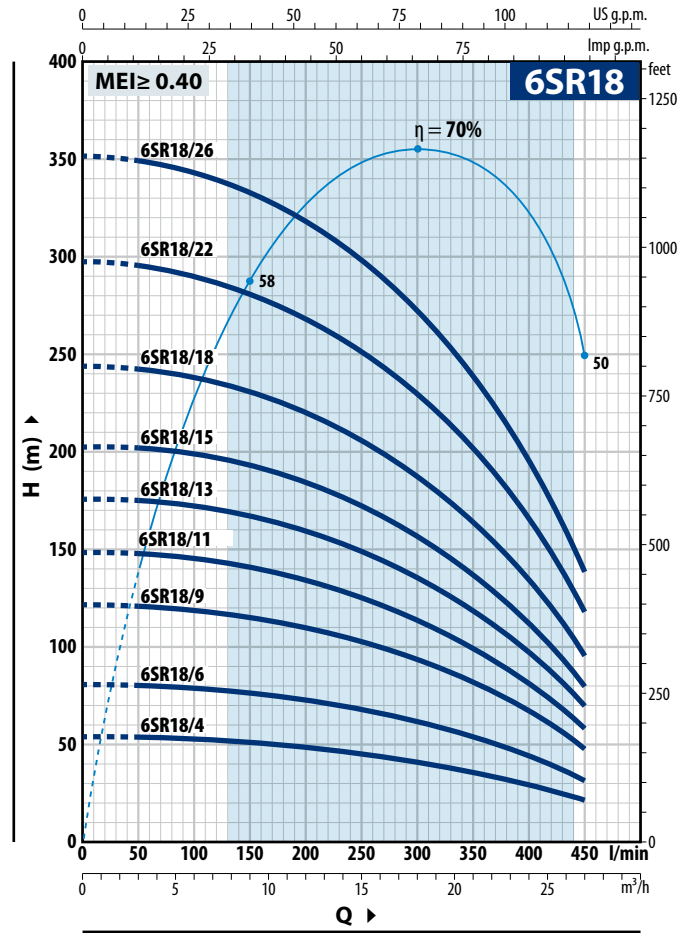
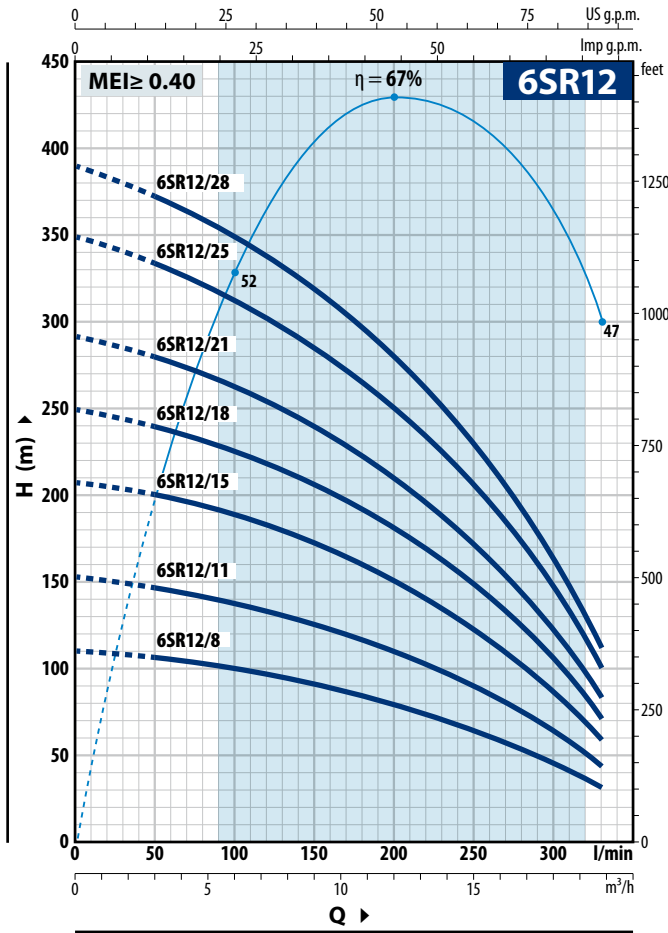

6SR12

MODEL	POWER (P ₂)		Q	Flow Rate								
	kW	HP		m ³ /h	0	3.0	6.0	9.0	12.0	15.0	18.0	19.8
Three-phase				0	50	100	150	200	250	300	330	
6SR 12/8	4	5.5	H metres	111	106	100	91	80	66	47	32	
6SR 12/11	5.5	7.5		153	146	138	125	110	91	65	44	
6SR 12/15	7.5	10		208	199	189	171	150	124	88	60	
6SR 12/18	9.2	12.5		250	239	225	205	180	149	106	72	
6SR 12/21	11	15		292	279	263	239	210	174	124	84	
6SR 12/25	13	17.5		349	331	313	285	250	206	147	100	
6SR 12/28	15	20		390	371	350	319	280	231	165	112	

6SR18

MODEL	POWER (P ₂)		Q	Flow Rate											
	kW	HP		m ³ /h	0	3	6	9	12	15	18	21	24	27	
Three-phase				0	50	100	150	200	250	300	350	400	450		
6SR 18/4	4	5.5	H metres	54	53.8	53	51	49	46	42	37	30	22		
6SR 18/6	5.5	7.5		81	80.5	79	77	74	69	63	55	45	32		
6SR 18/9	7.5	10		122	121	119	116	111	103	94	83	68	48		
6SR 18/11	9.2	12.5		149	148	145.5	141	135	126	115	101	83	59		
6SR 18/13	11	15		176	175	172	167	160	149	136	120	98	70		
6SR 18/15	13	17.5		203	202	199	193	185	172	157	138	113	80		
6SR 18/18	15	20		244	242	238	231	221	206	188	165	135	96		
6SR 18/22	18.5	25		298	296	291	282	270	252	230	202	165	118		
6SR 18/26	22	30		352	350	344	334	320	298	272	239	195	139		

Q = Flow rate H = Total manometric head

Tolerance of characteristic curves in compliance with EN ISO 9906 Grade 3B.

CHARACTERISTIC CURVES AND PERFORMANCE DATA

50 Hz n = 2900 min⁻¹

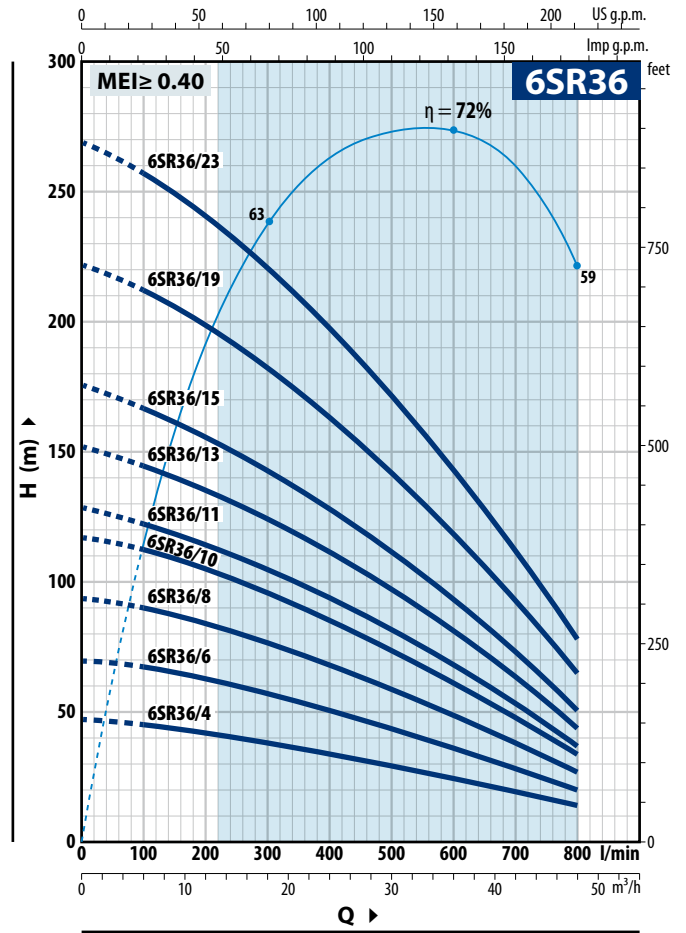
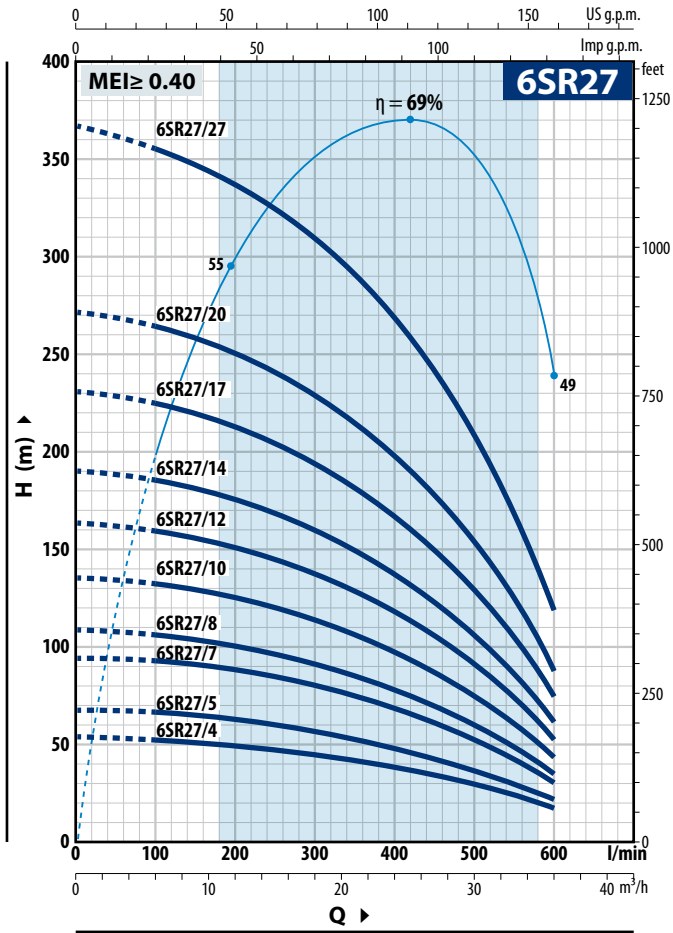

6SR27

MODEL	POWER (P ₂)		Q	H metres								
	kW	HP		0	6	12	18	24	30	36		
Three-phase			Q	0	100	200	300	400	500	600		
6SR 27/4	4	5.5	l/min	0	100	200	300	400	500	600		
6SR 27/5	5.5	7.5	m³/h	0	6	12	18	24	30	36		
6SR 27/7	7.5	10		54	53	49	45	40	30	18		
6SR 27/8	9.2	12.5		68	66	62	57	50	37	22		
6SR 27/10	11	15		95	92	87	80	70	52	31		
6SR 27/12	13	17.5		109	106	99	91	80	59	35		
6SR 27/14	15	20		136	132	124	114	100	74	44		
6SR 27/17	18.5	25		164	159	149	137	120	89	53		
6SR 27/20	22	30		191	185	174	160	140	104	62		
6SR 27/27	30	40		231	224	211	194	170	126	75		
				272	264	248	228	200	148	88		
				367	356	335	308	270	205	119		

6SR36

MODEL	POWER (P ₂)		Q	H metres								
	kW	HP		0	6	12	18	24	30	36	42	48
Three-phase			Q	0	100	200	300	400	500	600	700	800
6SR 36/4	4	5.5	l/min	0	100	200	300	400	500	600	700	800
6SR 36/6	5.5	7.5	m³/h	0	6	12	18	24	30	36	42	48
6SR 36/8	7.5	10		47	45	42	38	34	29	25	19	14
6SR 36/10	9.2	12.5		70	67	63	57	51	44	37	29	20
6SR 36/11	11	15		94	89	84	76	68	59	50	39	27
6SR 36/13	13	17.5		117	111	105	95	85	74	62	48	34
6SR 36/15	15	20		129	123	115	105	93	81	68	53	37
6SR 36/19	18.5	25		152	145	136	124	110	96	81	63	44
6SR 36/23	22	30		176	167	157	143	127	110	93	72	51
				222	212	199	181	161	140	118	92	65
				269	256	241	219	195	169	143	111	78

Q = Flow rate H = Total manometric head

Tolerance of characteristic curves in compliance with EN ISO 9906 Grade 3B.

CHARACTERISTIC CURVES AND PERFORMANCE DATA

50 Hz n = 2900 min⁻¹

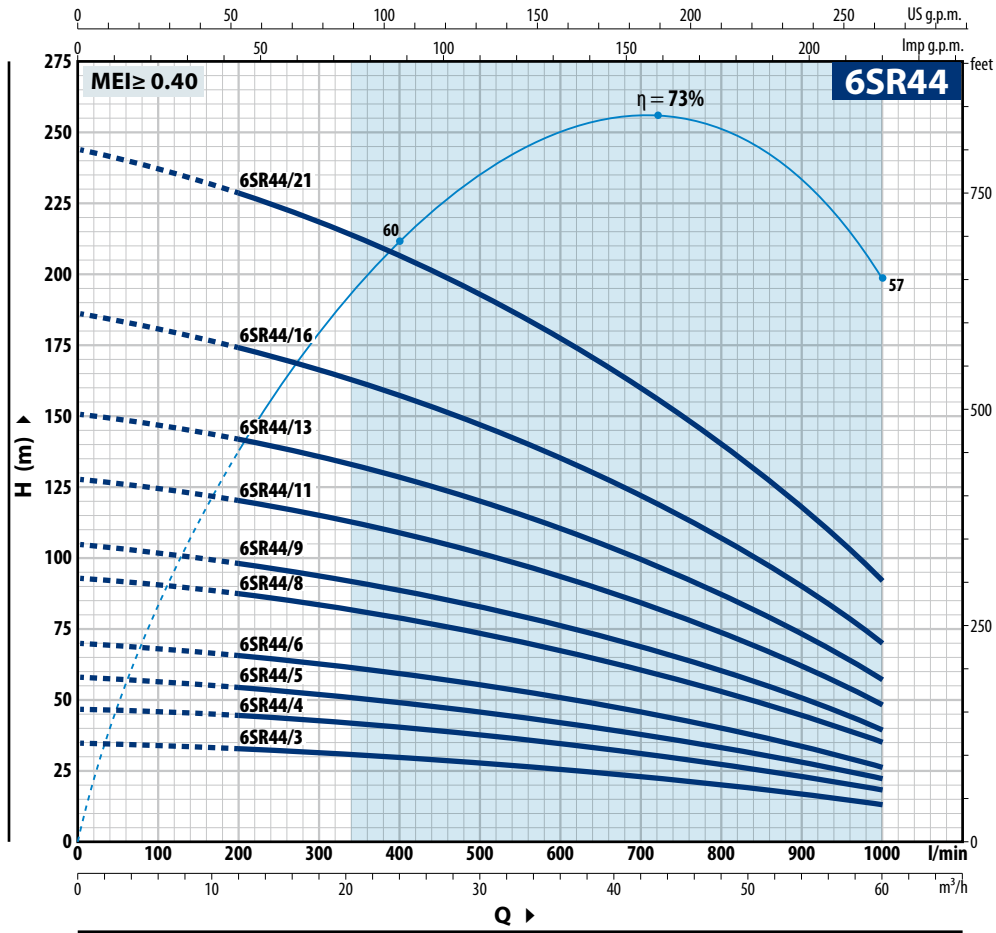

6SR44

MODEL	POWER (P ₂)		Q	Flow rate (Q)											
	kW	HP		0	12	18	24	30	36	42	48	54	60		
Three-phase			l/min	0	200	300	400	500	600	700	800	900	1000		
6SR 44/3	4	5.5	H metres	35	33	31	30	28	26	23	20	17	13		
6SR 44/4	5.5	7.5		47	44	42	40	37	34	31	27	23	18		
6SR 44/5	7.5	10		58	54	52	49	46	43	38	33	28	22		
6SR 44/6	9.2	12.5		70	65	62	59	56	51	46	40	34	26		
6SR 44/8	11	15		93	87	83	79	74	68	61	53	45	35		
6SR 44/9	13	17.5		105	98	93	89	83	77	69	60	51	39		
6SR 44/11	15	20		128	120	114	109	102	94	84	73	62	48		
6SR 44/13	18.5	25		151	141	135	128	120	111	99	86	73	57		
6SR 44/16	22	30		186	174	166	158	148	136	122	106	90	70		
6SR 44/21	30	40		244	228	218	207	194	179	160	139	118	92		

Q = Flow rate H = Total manometric head

Tolerance of characteristic curves in compliance with EN ISO 9906 Grade 3B.

TYPICAL INSTALLATION

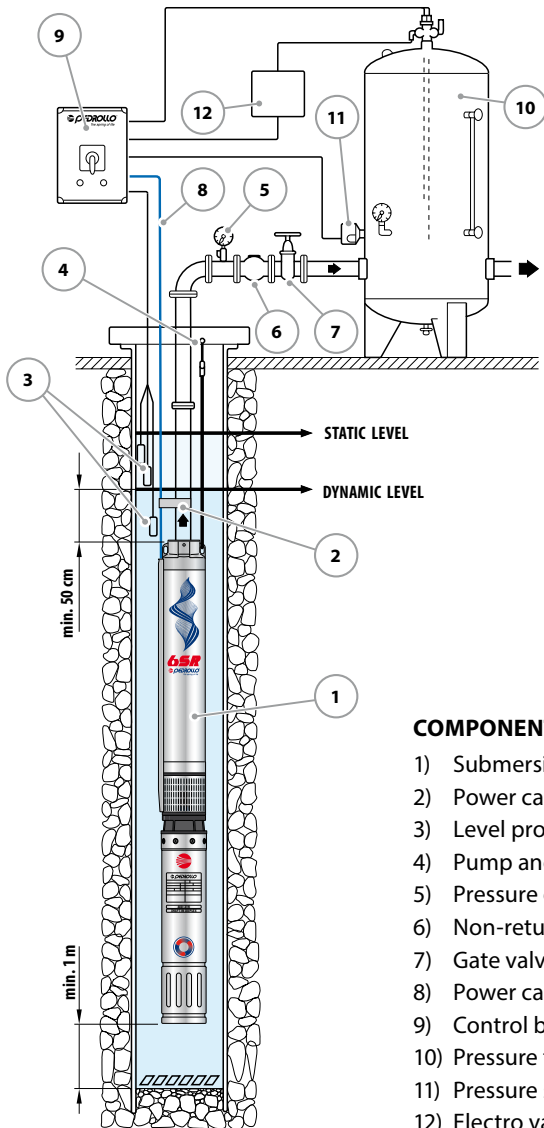

COMPONENTS

- 1) Submersible pump
- 2) Power cable clamps
- 3) Level probes
- 4) Pump anchorage
- 5) Pressure gauge
- 6) Non-return valve
- 7) Gate valve; for flow rate regulation
- 8) Power cable
- 9) Control box
- 10) Pressure tank
- 11) Pressure switch
- 12) Electro valve/electro-compressor

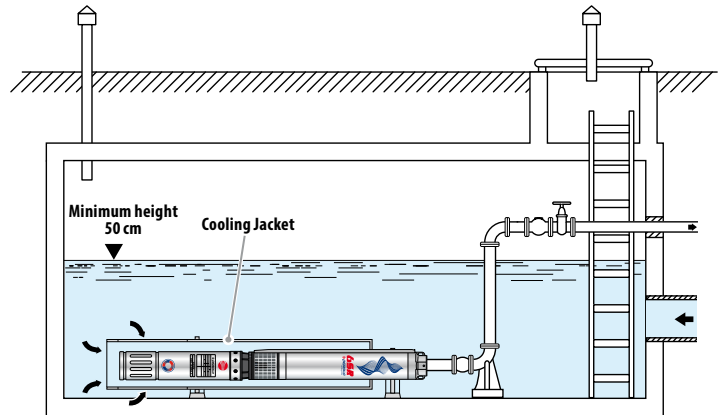

Cooling jacket

When the pump is installed in storage tanks, rivers or lakes an external jacket must be fitted to establish a flow of cooling water to prevent overheating of the motor.

➡ The **6SR** series pumps should be installed in boreholes of at least 6" (150 mm) in diameter. The pump should be lowered into the borehole, by means of the delivery pipe, to such a depth (min. 50 cm and at least one metre from the bottom) that it is completely immersed during operation when the level of water in the borehole may reduce. It is good practice to secure the pump by attaching a stainless steel cable to the anchorage points present on the delivery body.

6SR12-18-27 (Radial impellers)

POS. COMPONENT	CONSTRUCTION CHARACTERISTICS
1 DELIVERY BODY	Cast iron with an Epoxy Electro Coating treatment complete with threaded delivery port in compliance with ISO 228/1
2 NON-RETURN VALVE	Stainless steel AISI 304
3 MOTOR BRACKET	Cast iron with an Epoxy Electro Coating treatment in compliance with NEMA standards
4 IMPELLERS	Special-rubber coated Noryl
5 DIFFUSERS	Noryl
6 DIFFUSER CASING	Stainless steel AISI 304
7 PUMP SHAFT	Stainless steel AISI 304
8 PUMP BEARINGS	Elastomer housing with stainless steel AISI 316, chrome oxide coated, sand resistant shaft bushing
9 DRIVE COUPLING	Stainless steel AISI 420
10 FILTER	Stainless steel AISI 304
11 CABLE COVER	Stainless steel AISI 304
12 MOTOR 6"	6PD = rewindable oil filled submersible motor

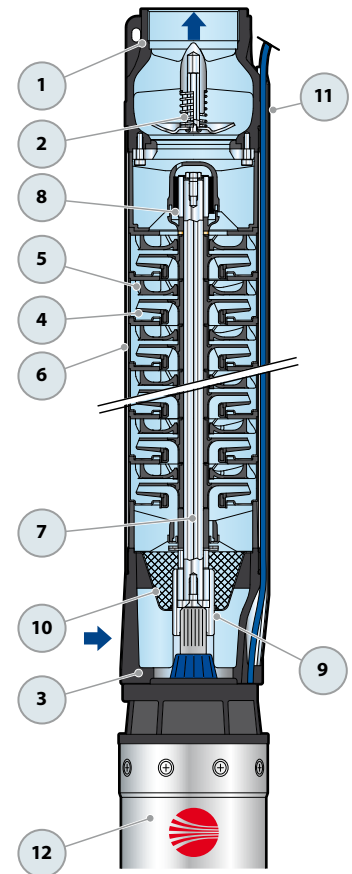

6SR36-44 (Semi-axial impellers)

POS. COMPONENT	CONSTRUCTION CHARACTERISTICS
1 DELIVERY BODY	Stainless steel AISI 304 complete with threaded delivery port in compliance with ISO 228/1
2 NON-RETURN VALVE	Stainless steel AISI 304
3 MOTOR BRACKET	Cast iron with an Epoxy Electro Coating treatment in compliance with NEMA standards
4 IMPELLERS	Noryl e ricoperte in gomma speciale
5 DIFFUSERS	Noryl
6 DIFFUSER CASING	Stainless steel AISI 304
7 PUMP SHAFT	Stainless steel AISI 304
8 PUMP BEARINGS	Special technopolymer housing with stainless steel AISI 316, chrome oxide coated, sand resistant shaft bushing
9 DRIVE COUPLING	Stainless steel AISI 420
10 FILTER	Stainless steel AISI 304
11 CABLE COVER	Stainless steel AISI 304
12 MOTOR 6"	6PD = rewindable oil filled submersible motor

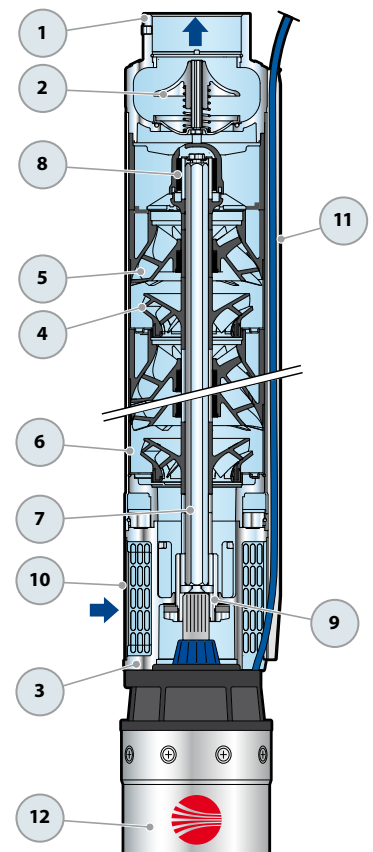

DIMENSIONS AND WEIGHT

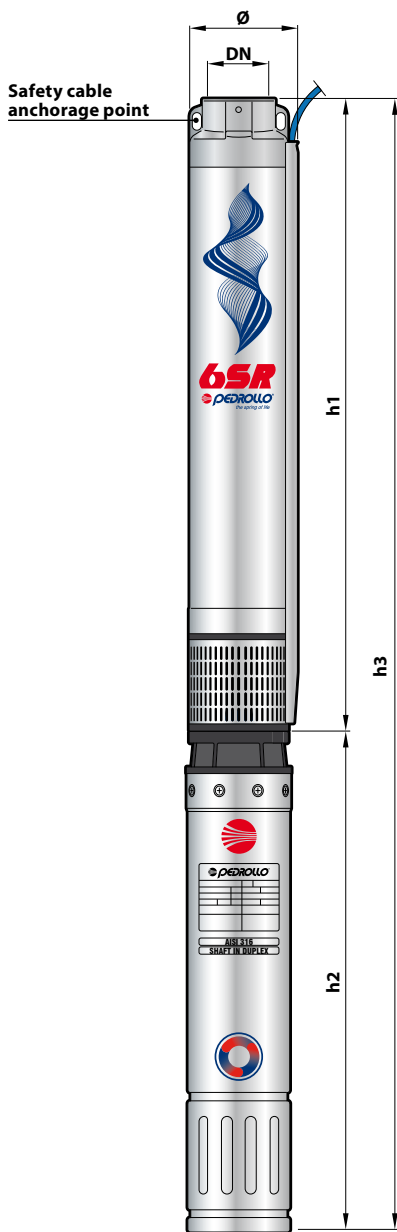

MODEL	PORT DN	Ø	DIMENSIONS mm			kg 3~
			h1	h2	h3	
6SR 12/8 - PD	3"	149.5	719	595	1314	53.8
6SR 12/11 - PD			849	625	1474	60.9
6SR 12/15 - PD			1068	660	1728	66.8
6SR 12/18 - PD			1198	700	1898	73.0
6SR 12/21 - PD			1328	765	2093	83.9
6SR 12/25 - PD			1502	820	2322	96.0
6SR 12/28 - PD			1632	820	2452	98.1
6SR 18/4 - PD			545	595	1140	49.6
6SR 18/6 - PD			632	625	1257	53.6
6SR 18/9 - PD			762	660	1422	60.3
6SR 18/11 - PD			849	700	1549	67.0
6SR 18/13 - PD			981	765	1746	76.9
6SR 18/15 - PD			1068	820	1888	84.6
6SR 18/18 - PD			1198	820	2018	87.6
6SR 18/22 - PD			1371	883	2254	99.7
6SR 18/26 - PD			1545	953	2498	125.7
6SR 27/4 - PD			583	595	1178	47.9
6SR 27/5 - PD			636	625	1261	53.5
6SR 27/7 - PD			742	660	1402	58.8
6SR 27/8 - PD			795	700	1495	63.0
6SR 27/10 - PD			901	765	1666	74.1
6SR 27/12 - PD			1051	820	1871	83.6
6SR 27/14 - PD			1157	820	1977	85.9
6SR 27/17 - PD			1316	883	2199	97.5
6SR 27/20 - PD			1474	953	2427	123.0
6SR 27/27 - PD			1845	1098	2943	135.8
6SR 36/4 - PD			823	595	1418	55.4
6SR 36/6 - PD			1049	625	1674	64.0
6SR 36/8 - PD			1275	660	1935	71.0
6SR 36/10 - PD			1501	700	2201	76.2
6SR 36/11 - PD			1613	765	2378	90.0
6SR 36/13 - PD			1839	820	2659	102.0
6SR 36/15 - PD			2065	820	2885	107.0
6SR 36/19 - PD			2517	883	3400	121.0
6SR 36/23 - PD			2969	953	3922	154.0
6SR 44/3 - PD			710	595	1305	54.0
6SR 44/4 - PD			823	625	1448	57.5
6SR 44/5 - PD			936	660	1596	63.1
6SR 44/6 - PD			1049	700	1749	70.0
6SR 44/8 - PD			1275	765	2040	82.2
6SR 44/9 - PD	1388	820	2208	92.0		
6SR 44/11 - PD	1613	820	2433	97.0		
6SR 44/13 - PD	1839	883	2722	110.0		
6SR 44/16 - PD	2178	953	3131	141.0		
6SR 44/21 - PD	2743	1098	3841	154.3		

6PD = rewindable oil filled submersible motor

DIMENSIONS AND WEIGHT (PUMP ONLY)



MODEL Pump	PORT DN	DIMENSIONS mm		kg
		Ø	h1	
6SR 12/8 - HYD	3"	149.5	719	19.8
6SR 12/11 - HYD			849	24.9
6SR 12/15 - HYD			1068	27.8
6SR 12/18 - HYD			1198	31.0
6SR 12/21 - HYD			1328	33.9
6SR 12/25 - HYD			1502	39.0
6SR 12/28 - HYD			1632	41.1
6SR 18/4 - HYD			545	15.6
6SR 18/6 - HYD			632	17.6
6SR 18/9 - HYD			762	21.3
6SR 18/11 - HYD			849	25.0
6SR 18/13 - HYD			981	26.9
6SR 18/15 - HYD			1068	27.6
6SR 18/18 - HYD			1198	30.6
6SR 18/22 - HYD			1371	34.7
6SR 18/26 - HYD			1545	38.7
6SR 27/4 - HYD			583	13.9
6SR 27/5 - HYD			636	17.5
6SR 27/7 - HYD			742	19.8
6SR 27/8 - HYD			795	21.0
6SR 27/10 - HYD			901	24.1
6SR 27/12 - HYD			1051	26.6
6SR 27/14 - HYD			1157	28.9
6SR 27/17 - HYD			1316	32.5
6SR 27/20 - HYD			1474	36.0
6SR 27/27 - HYD			1845	44.8
6SR 36/4 - HYD			823	21.4
6SR 36/6 - HYD			1049	28.0
6SR 36/8 - HYD			1275	32.0
6SR 36/10 - HYD			1501	34.2
6SR 36/11 - HYD			1613	40.0
6SR 36/13 - HYD			1839	45.0
6SR 36/15 - HYD			2065	50.0
6SR 36/19 - HYD			2517	56.0
6SR 36/23 - HYD			2969	67.0
6SR 44/3 - HYD			710	20.0
6SR 44/4 - HYD			823	21.5
6SR 44/5 - HYD			936	24.1
6SR 44/6 - HYD			1049	28.0
6SR 44/8 - HYD			1275	32.2
6SR 44/9 - HYD			1388	35.0
6SR 44/11 - HYD			1613	40.0
6SR 44/13 - HYD	1839	45.0		
6SR 44/16 - HYD	2178	54.0		
6SR 44/21 - HYD	2743	63.3		